

OPTI-Line OCLC MED



GB Operating Instructions





OCLC MED 25
OCLC MED 50
OCLC MED 70

Safety First:

The owner of this unit is responsible that everyone who is working on the unit observes the safety rules and reads the whole operation instructions and understand it. A wrong or poorly maintained unit could cause high body risk or even risk of death.

Table 1 Contact Details

<p>Manufacturer</p>	<p>Pfannenbergs Electro-Technology (Suzhou) Co. Ltd. No. 108, Xinglin Street SIP Suzhou 215026 Jiangsu, P.R. China T: +86 400 928 9655 T: +86 512 6790 3091 F: +86 512 6287 1077 E: service@pfannenbergs.cn W: www.pfannenbergs.cn</p>
<p>Service</p>	<p>ait-deutschland GmbH Industriestraße 3 95359 Kasendorf Germany T: +49 9228 9977 7190 F: +49 9228 9977 7474 E: service@kkt-chillers.com W: www.kkt-chillers.com</p> 
<p>Service USA</p>	<p>KKT chillers, Inc. 765 Dillon Drive Wood Dale IL-60191 T: +1 833 558 4357 F: +1 847 734 1601 TF: +1 866 517 6867 E: techsupport@kkt-chillersusa.com</p> 
<p>Service Asia</p>	<p>Pfannenbergs Electro Sales (Suzhou) Co., Ltd. Business Unit KKT chillers No. 108, Xinglin Street SIP Suzhou 215026 Jiangsu, P.R. China T: +86 400 928 9655 T: +86 512 6790 3091 E: service@kkt-chillerscn.com W: www.kkt-chillers.com</p> 

Introduction

These operating instructions have been drawn up by KKT chillers on the basis of the Machinery Directive 2006/42/EC. They contain all important information and instructions for the installation and safe operation of the refrigerating machine (chiller). It also contains advice on how to prevent or correct faults.

Please allow yourself sufficient time to read through these instructions carefully and to digest all the information this document contains. If you have any further questions, please contact the KKT chillers Service Team using the contact details provided.

If properly used for its intended use and correctly maintained, the chiller ensures sustained, fault-free operation. The methods and procedures described in these instructions should help you to detect problems early and to take appropriate countermeasures.

If you keep to the maintenance program as described, you ensure the reliability and safety of the machine. You also keep the operating costs low and at the same time increase the life of the components.

To ensure that the performance of your chiller is not impaired, we recommend that you only use original spare parts purchased from KKT chillers. In this way you ensure the reliability and quality of the machine.

	ATTENTION! A black exclamation mark on a yellow background in a triangle indicates important information and instructions to which you must pay particular attention and must always follow.
---	---

KKT chillers reserves the right to change technical details without prior notice. The illustrations in this document are not to scale!

As the OCLC MED units can be adapted to specific projects, this document only contains information that is generally valid for all units in the series.

All project-specific data is enclosed with the unit in separate summary documentation.

- Machine configuration
- Parameter list
- System Flow Chart
- Electrical diagram
- All other project specific details

Contents

Introduction	2
1 Product Description	6
1.1 Intended Use	6
1.2 Technical Data	7
1.2.1 OCLC MED 25	7
1.2.2 OCLC MED 50	8
1.2.3 OCLC MED 70	9
1.3 Appearance	10
1.4 Explanation of Terms	10
2 Function and Main Components	11
2.1 Compressor	11
2.2 Evaporator	11
2.3 Condenser	12
2.4 Expansion Valve	12
2.5 Refrigerant	12
2.6 Oil	12
2.7 Filter Dryer	12
2.8 Pressure Sensors	12
2.9 Temperature Sensors	13
2.10 Heater for Compressor and Control Cabinet	13
2.11 Control Unit/Main Circuit Board	13
2.12 Display	13
2.13 Pump	13
2.14 Fan	13
2.15 Control Cabinet	14
2.16 Water Quality	15
3 Options	16
3.1 Hot Gas Bypass for High Accuracy Control	16
4 Accessorises	17
4.1 Seaworthy Crate Packaging (Accessories)	17
4.2 Remote Control Panel (Accessories)	17
4.3 Hydraulic Kit (Accessories)	17
4.4 Transformer for special voltages (Accessories only for OCLC MED 25)	17
4.5 Switch over cabinet (Accessories)	18
5 Safety	19
5.1 General Information	19
5.2 Hazard Warnings	19
5.3 Residual Energy	20
5.4 Safety Devices and Safeguards	21
5.4.1 High Pressue Limiter	21
5.4.2 High Pressure Monitoring	21
5.4.3 Low Pressure Monitoring	22
5.4.4 Flow Monitoring	22
5.4.5 Personal protective equipment when operating the machine	22

5.5	Personal protective equipment for servicing work	22
5.6	Airborne Sound Emissions	23
5.7	Notes on Reducing Noise and Vibration.....	23
5.7.1	Noise	23
5.7.2	Vibration.....	23
5.8	Residual Risks.....	23
5.8.1	Electrical	23
5.8.2	Mechanical	23
5.8.3	Chemical	24
5.8.4	Others	24
5.9	Dangerous Substances	24
5.9.1	Refrigerant R410A	24
5.9.2	Oil FV68S	25
5.10	Reasonably Foreseeable Misuse	26
5.11	Information for Emergencies.....	26
6	Handling and Storage.....	28
6.1	Transport	28
6.1.1	Forklift Truck.....	28
6.1.2	Crane.....	29
6.2	Unpacking.....	30
6.3	Storage	30
7	Installation	31
7.1	Overview	31
7.2	Installation Site	31
7.2.1	General Information	31
7.2.2	Minimum Room Volume	31
7.2.3	Ambient Temperature	31
7.2.4	Effect of Surrounding Air Flow	32
7.2.5	Minimum Clearances.....	32
7.2.6	Surface and Foundation	32
7.2.7	Installation.....	33
7.2.8	Hydraulic Installation	33
7.2.9	Frost Protection Measures	34
7.2.10	Flushing the Cold Water Circuit.....	34
7.2.11	Filling.....	34
7.2.12	Venting.....	34
7.2.13	Electrical Installation.....	35
7.2.14	Grounding.....	36
8	Commissioning	37
8.1	Installation Checklist	37
9	Operation	38
9.1	Switching On.....	38
9.2	Selecting the Operating Mode.....	38
9.3	External Release	38

9.4	Control	38
9.5	Control Panel.....	39
9.5.1	Start Screen.....	40
9.5.2	Customer Menu.....	40
9.5.3	Information	41
9.5.4	Start/Stop	42
9.5.5	Setting Points	42
9.5.6	Alarm Menu	42
9.6	Controller Description	43
9.6.1	Chiller Start and Stop.....	43
9.6.2	Water Temperature Control	43
9.6.3	Compressor Control	43
9.6.4	Fan Speed Control.....	44
9.6.5	Electronic Expansion Valve Control.....	44
9.6.6	Temperature Limit Monitoring.....	44
9.6.7	Alarm Message.....	44
9.7	Phase Sequence Check Process.....	45
10	Service.....	46
10.1	Maintenance	46
10.2	Fault Correction.....	46
10.3	Spare Parts.....	46
11	Taking Out of Service	47
12	Recycling	48
13	Products, Solutions and Services.....	49
14	Lists	50
14.1	List of Illustrations	50
14.2	List of Tables	51
I.	Troubleshooting.....	52
II.	Maintenance intervals in accordance with the VDMA	55
III.	Product Registration.....	58
IV.	Information Ecodesing	59

1 Product Description

Please read all the points in these operating instructions before starting up the machine. You should pay particular attention to the points on safety, commissioning/start-up and operation. If you have further questions about your machine, please contact the KKT chillers Service Team (see **Table 1 Contact Details**).

1.1 Intended Use



The OCLC MED is a factory-tested, fully automatic compressor chiller. The machine is solely for cooling liquids (fluids) in accordance with EN 378-1. An adequate supply of cooling air must be provided. Only approved liquids may be used. The OCLC MED corresponds to protection class IP 54 (when the housing is closed) and is suitable for both indoor and outdoor installation (note the options packages).

The operator is responsible for complying with the specified operating, servicing and maintenance conditions according to these operating instructions.

The owner of the chiller, not the manufacturer, is responsible and liable for all personal injuries and damage to property caused by improper use of the unit (misuse).

Table 2 shows the general safety instructions of the chiller. These are attached to the machine in a clear and readily visible position. A complete description of all hazard warnings is given in **Chapter 5.2 Hazard Warnings**.

Table 2 Safety Instructions

	Note and follow the instructions for use!
	Before opening the machine, it must be disconnected from the power supply! After disconnecting the machine from the power supply, always wait for at least 2 minutes before opening it.
	Danger! High voltage! If the machine is only switched off at its main switch, dangerous electrical voltage is still present at several terminals in the control cabinet.

1.2 Technical Data

1.2.1 OCLC MED 25

Manufacturer	Pfannenbergl Electro-Technology
Chiller	OPTI-Line
Type	OCLC MED 25
Cooling Capacity(kW) @ T _w =12°C /T _{amb} =45°C	27
Refrigerant	R410A
GWP	2088
Refrigerant Charge(kg)	5.1
CO ₂ Equivalent(t)	10.6
Coolant	30% to 40% Ethylene Glycol Mixture
Accuracy (K)	± 2
Ambient Temperature(°C)	(Standard -25 to +45) (Optional -40 to +45) Low temp version (Optional -25 to +55) High temp version
Supply Temperature(°C)	+6 to +14
Maximum Airflow(m ³ /h)	17,000
Protection Class EN 60529 with closed housing	IP54
Operating Voltage	400V/3P/50Hz 460V/3P/60Hz
Overcurrent Protection (A)	35
Control Voltage	24 VDC
Sound Pressure Level [dB(A)] @ 5m distance	55
Footprint (mm) Length * Width * Height	1925 * 1003 * 1750
Net Weight (kg)	530
Gross Weight (kg)	540
Flow rate (m ³ /h)	3.0 to 6.0
Rated Pumping Pressure(m)	40
Leak Test Attention: Return Safety Valve Pressure(bar)	3

1.2.2 OCLC MED 50

Manufacturer	Pfannenbergl Electro-Technology
Chiller	OPTI-Line
Type	OCLC MED 50
Cooling Capacity(kW) @ T _w =12°C /T _{amb} =45°C	44
Refrigerant	R410A
GWP	2088
Refrigerant Charge(kg)	6.6
CO ₂ Equivalent(t)	13.8
Coolant	30% to 40% Ethylene Glycol Mixture
Accuracy (K)	± 2
Ambient Temperature(°C)	(Standard -25 to +48) (Optional -40 to +48) Low temp version
Supply Temperature(°C)	+6 to +14
Maximum Airflow(m ³ /h)	17,000
Protection Class EN 60529 with closed housing	IP54
Operating Voltage	400V/3P/50Hz
Overcurrent Protection (A)	60
Control Voltage	24 VDC
Sound Pressure Level [dB(A)] @ 5m distance	60
Footprint (mm) Length * Width * Height	1925 * 1003 * 1750
Net Weight (kg)	678
Gross Weight (kg)	688
Flow rate (m ³ /h)	2.4 to 7.2
Rated Pumping Pressure(m)	30
Leak Test Attention: Return Safety Valve Pressure(bar)	3

1.2.3 OCLC MED 70

Manufacturer	Pfannenbergl Electro-Technology
Chiller	OPTI-Line
Type	OCLC MED 70
Cooling Capacity(kW) @ T _w =12°C /T _{amb} =45°C	69
Refrigerant	R410A
GWP	2088
Refrigerant Charge(kg)	10.0
CO ₂ Equivalent(t)	20.9
Coolant	30% to 40% Ethylene Glycol Mixture
Accuracy (K)	± 2
Ambient Temperature(°C)	(Standard -25 to +48) (Optional -40 to +48) Low temp version
Supply Temperature(°C)	+6 to +14
Maximum Airflow(m ³ /h)	21,000
Protection Class EN 60529 with closed housing	IP54
Operating Voltage	400V/3P/50Hz
Overcurrent Protection (A)	80
Control Voltage	24 VDC
Sound Pressure Level [dB(A)] @ 5m distance	60
Footprint (mm) Length * Width * Height	2225 * 1177 * 2049
Net Weight (kg)	781
Gross Weight (kg)	804
Flow rate (m ³ /h)	7.2 to 14.4
Rated Pumping Pressure(m)	30
Leak Test Attention: Return Safety Valve Pressure(bar)	3

1.3 Appearance

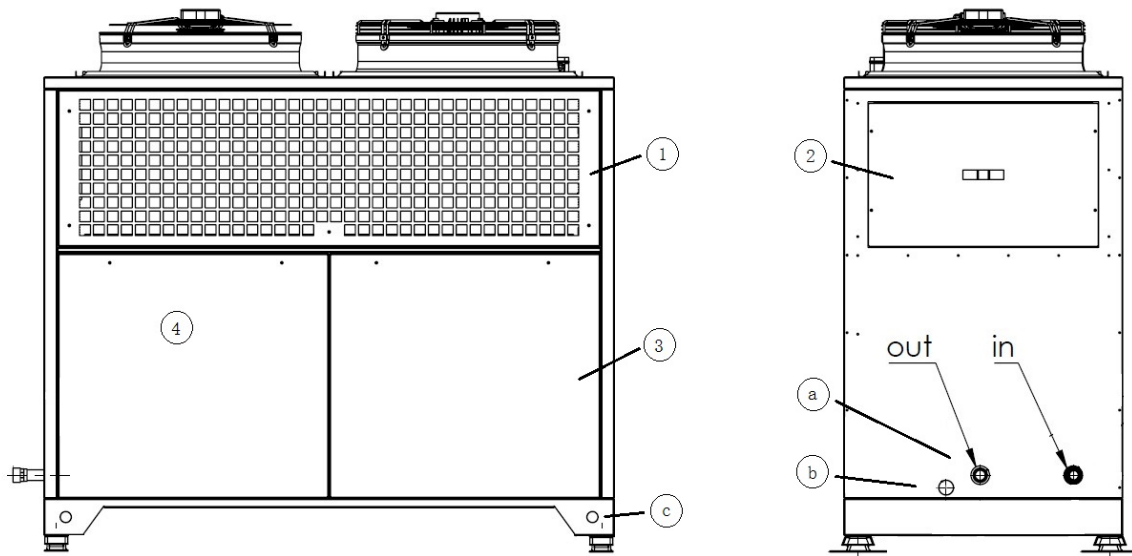

1	Condenser protective grating	a	Water connection
2	Metal cladding, side service	b	Wiring connection
3	Metal cladding, bottom service	c	Lifting hole
4	Control cabinet location (opposite side)		

1.4 Explanation of Terms

A few important terms which appear in this document are briefly explained here for improved understanding.

Table 3 Explanation of Terms

Term	Explanation
Application	The heat source connected hydraulically with the chiller.
Process circuit	Application and piping to the chiller.
Cold water cycle	The process circuit and chiller in hydraulic piping.
Cold water	Cooling medium in the cold water circuit.
Cooling air	Ambient air drawn through the machine, which absorbs the heat.
Net weight	Ready to operate machine without coolant.
Gross weight	Ready to operate machine including coolant.

2 Function and Main Components

The chiller consists of the main components: compressor, condenser, expansion valve and evaporator, which are arranged in a circuit **Figure 1**.

Refrigerant circulates in this circuit (cycle). It absorbs heat from the cold water in the evaporator and gives it up to the ambient air in the condenser.

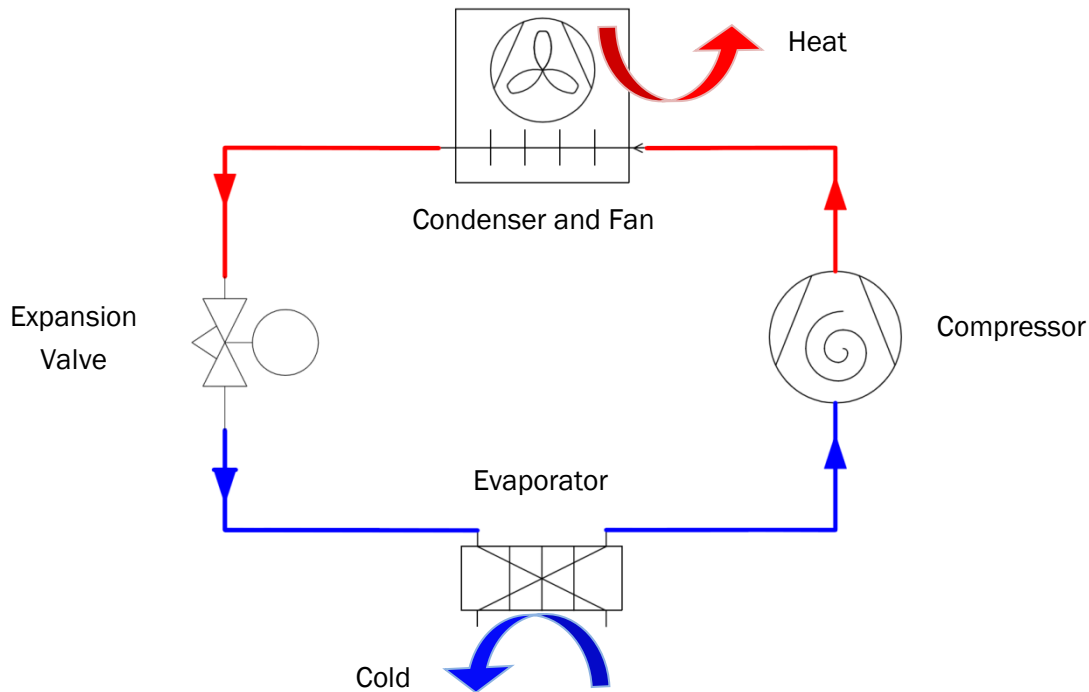

Figure 1 Refrigerant Diagram

In addition, diverse pressure and temperature sensors, a control unit, a high-pressure switch, one or more pumps and one or more fans are also installed for control and operation of the chiller.

2.1 Compressor

The compressor generates the pressure difference between the heat sink and heat source in the refrigerant circuit needed for evaporation and condensing. Coolant vapor from the evaporator is drawn in and compressed to the condensing pressure in the compressor.

The compressors used operate according to the scroll principle. Scroll compressors are maintenance-free, quiet and have a very high efficiency.

The flow temperature is controlled by switching on or off one or more compressors (see **9.6.3 Compressor control**). Sequential changeover ensures that all compressors are loaded uniformly.

2.2 Evaporator

The evaporator is a plate heat exchanger which transfers heat from the cold water to the refrigerant. In order for the heat transfer to take place, the refrigerant in the evaporator has a lower temperature than the cold water and when it absorbs heat it changes its physical state from liquid to gaseous.

If the cold water is contaminated, deposits can form on the transfer surfaces of the evaporator. These impair the heat transfer to the refrigerant and reduce the refrigerating capacity of the machine. For this reason, always ensure the specified water quality and do not use any other additives than those specified.

2.3 Condenser

The condenser is a microchannel heat exchanger which transfers heat from the refrigerant to the ambient air. In order for the heat transfer to take place, the refrigerant in the condenser has a higher temperature than the ambient air drawn in and when it gives off heat its physical state changes from gaseous to liquid.

Contaminated cooling air can cause deposits to form on the surface of the condenser over time. This impairs heat transfer to the refrigerant which restricts the operating limit of the machine and reduces the machine's refrigerating capacity.

2.4 Expansion Valve

The expansion valve controls the admission of liquid refrigerant to the evaporator and at the same time restricts the pressure of the refrigerant before it enters the evaporator. With this restriction the refrigerant cools to the evaporation temperature.

The expansion valve used in your machine is controlled electronically. The electronic control ensures that the evaporator is always optimally supplied with refrigerant. This improves the COP (Coefficient of Performance) and reduces pressure fluctuations in the refrigeration circuit.

2.5 Refrigerant

The refrigerant R410A circulates in the refrigeration circuit. It conveys heat from the evaporator to the condenser and at the same time continuously changes its physical state.

R410A is a zeotropic mixture of 50% each R32 and R125 with virtually negligible temperature glide. R410A has a very high volumetric refrigerating capacity and has no ozone depletion potential (ODP=0). A corresponding safety data sheet can be obtained from the KKT chillers Service Team (see **Table 1 Contact Details**).

2.6 Oil

The components of the compressor subject to friction are lubricated by oil, which is added to the refrigerant in the factory. The FV68S is used for this. The oil is soluble in the refrigerant and is distributed with it throughout the refrigeration circuit. The total oil quantity of the respective unit is given in the technical data. A corresponding safety data sheet can be obtained from the KKT chillers Service Team (see **Table 1 Contact Details**).

2.7 Filter Dryer

The task of the filter dryer is to absorb any contamination or moisture from the refrigerant circuit. Both refrigerant and oil are hygroscopic. When the refrigeration circuit is installed the oil can absorb moisture. This moisture can cause corrosion and has a negative effect on the cooling process. The filter dryer bonds this moisture and has also a mechanical filter effect. If work is carried out on the refrigeration circuit requiring it to be opened, the filter dryer must be replaced.

2.8 Pressure Sensors

The pressure sensors used are compact pressure transmitters with piezo resistive measuring cell. The sensors register the system pressure continuously in different places within the refrigerant and cold water circuit. The values are used to control the system and for visualization at the controller display.

2.9 Temperature Sensors

The temperature sensors used are equipped with a platinum measuring cell. The sensors register the temperature continuously in different places within the refrigerant and cold water circuit. The values are used to control the system.

2.10 Heater for Compressor and Control Cabinet

The oil sump heater prevents refrigerant from becoming deposited in the oil of the compressor at low ambient temperatures. When the compressor is started up this refrigerant would be liberated from the oil as gas and make the oil foam up. Under these basic conditions the lubrication of components in the compressor subject to friction would be poor and the compressor could be damaged.

The control cabinet heating is controlled thermostatically and, at low ambient temperatures, it prevents moisture from the ambient air drawn in condensing on the electrical and electronic components of the cabinet thereby damaging them.

For both heaters to be active, the chiller must not be disconnected from the power supply (**9.2 Selecting the operating mode**).

2.11 Control Unit/Main Circuit Board

The control unit is programmed in the factory. All system readings and information come together on it. In addition, the electrical components are controlled via algorithms

2.12 Display

The display is used to visualize the information required by the operator and the system processes. It is also possible to make entries at it. The display communicates with the control unit. Further information on operation is given in **Chapter 9.5 Control panel**.

2.13 Pump

The chiller's pump ensures the necessary circulation of the cold water. For normal operation ("ON" mode), the pump will run 24 hours per day without stop. Pump will stop when the water flow rate is too low or the motor become overload, then the alarm will be shown on the display for troubleshooting.

2.14 Fan

The fan draws the cooling air from the surroundings through the condenser and blows out the heated air upwards out of the chiller. To prevent injuries, the fan is protected against accidental contact by protective grilles. The fan's speed is variable and is controlled by the main printed board. The speed of the fan is essentially controlled by the condensing pressure. The fans are protected against thermal overload. It will automatically switch or stop according to actual alarm.

2.15 Control Cabinet

The control cabinet conforms to the requirements of EN 60204 and contains the electrical and electronic components for controlling the chiller. After removing the bottom service panel (see electrical signal) the control cabinet is accessible and can be opened using a standard two-way key.

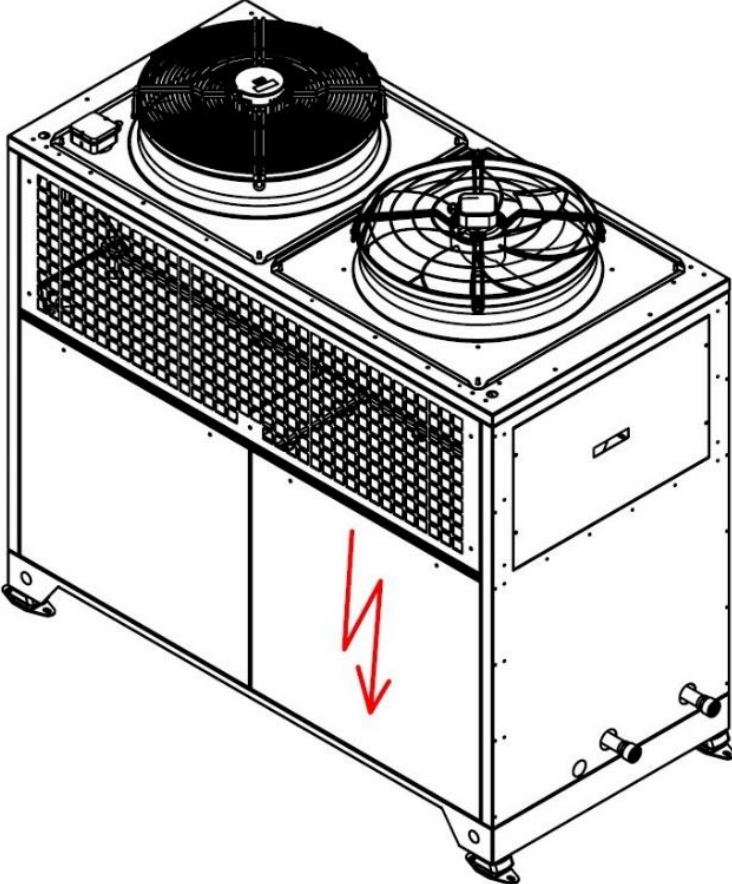

Figure 2 Control Cabinet Cover

2.16 Water Quality

The following limits must be maintained for safe operation of the equipment:

Table 4 Water Quality

Property / components	Unit	Value Range
pH value (20 °C)	-	7-9
Saturation index	-	-0.2 < 0 < +0.2
Conductivity	µS/cm	80-500
Water hardness	°dH	< 5.6
Carbonate hardness	mol/m ³	< 0.5
Total plate count	K/ml	< 10000
Grain size	µm	< 300
Glycol fraction (AFN)	Vol%	30-40
Oil fraction	Vol%	0
Chloride (Cl ⁻)	mg/l	< 50
Sulphate	mg/l	< 50
Nitrate	mg/l	< 100
Copper	mg/l	< 0.1
Iron	mg/l	< 0.2
Free carbonic acid	mg/l	< 20
Manganese	mg/l	< 0.1
Ammonia	mg/l	< 2
Free chloride	mg/l	< 0.5
Sulphide	mg/l	< 0.03

In order to avoid a restriction of the plate heat exchanger the above listed limit values have to be guaranteed imperatively.

Furthermore, mucilage bacteria are not allowed in the cooling water. If that is not possible, KKT chillers can recommend an accordant inhibitor based on a biologic water analysis.

3 Options

3.1 Hot Gas Bypass for High Accuracy Control

To get a more stable and accurate water temperature control, the chillers are configured with an additional load modulating valve. Therefor the output of the refrigeration circuit is adjusted to the cooling demand by an electronically controlled valve. Unlike to a control by switching compressors on or off, a higher target constant is achieved by the continuous regulation of the valve.

4 Accessories

The chiller can be equipped in the factory with the Accessories described in the following.

The items marked "Accessories" are enclosed with the unit, unattached, and can be reordered at any time using the appropriate product number. The installer of the machine is responsible for installing the Accessories. You can also ask the KKT Chillers Service Team to arrange for this installation (see **Table 1 Contact Details**).

Details of your machine's equipment are given in the separate summary documentation.

4.1 Seaworthy Crate Packaging (Accessories)

The seaworthy crates are produced according to International Standards for Phytosanitary Measures with packaging made of solid wood (ISPM 15). This means that the crates are made of heat-treated solid wood which has been stripped of its bark. Only wood-based materials, such as OSB boards, are used. In addition, all crates are marked with the IPPC logo and registration number. The units are fixed in the crate with the help of coach bolts, ring nuts and polyester straps and are packed in a sea air consistent foil with desiccant. The components used to pack the units can be dismantled using a crosshead screwdriver.

4.2 Remote Control Panel (Accessories)

In case the chiller shall not be operated from the machine itself but from a different operating place the chiller can be delivered with a remote-control panel. Thereby the same display is mounted together with the operating voltage supply in one housing. The remote-control panel can be connected to the chiller via the RS485 interface and takes over the complete function of the controller in the main device. By setting the accordant jumper in the switch cabinet of the main device, the required operating source can be chosen.

4.3 Hydraulic Kit (Accessories)

To have a better protection and monitoring of the coolant circuit, the customer could order a hydraulic kit for your chiller. The hydraulic kit includes water filter, flow indicator, flow regulating valve, automatic air-bleeding valve, ball valves and some fittings. The water filter could protect the coolant circuit against dirt and ensure a good water quality for longer lifetime. Customer could use the flow regulating valve and flow indicator to regulate and check the actual flow rate.

4.4 Transformer for special voltages (Accessories only for OCLC MED 25)

If the chiller is to be operated with a voltage of 400V/3~/60 or 200V/3~/60, a transformer must be connected upstream of the system. This transformer is not integrated into the chiller but is to be mounted as a stand alone component (with own housing and 5m cable) next to the chiller.

909000.0112 transformer 400V/3~/60

909000.0120 transformer 200V/3~/60

4.5 Switch over cabinet (Accessories)

This Switch over cabinet is used for sequence switching and fault switching for two Independently working chiller.

The sequence switching is controlled by a timer in which the time can be freely adjustable

If a collective fault message in the OCLC MED is active it will be switched to the inactive Chiller with a potential-free contact. The switch over cabinet takes the remote control of the devices as a superior component.

5 Safety

When used as intended, the chiller is designed to operate safely, provided that the instructions concerning transport, installation, commissioning/startup and maintenance given in these operating instructions are complied with. The machine conforms to the safety standards in accordance with the EC Declaration of Conformity (see **Appendix IV Information Eco**).









5.1 General Information



The chiller contains a high-pressure circuit. The maximum pressure that occurs is 45 bar. Even when inactive or disconnected from the power supply the circuit is still under pressure.

5.2 Hazard Warnings

A number of warning labels are applied to the machine. Keep these warnings clean at all times. Damaged or missing warnings must be replaced.







Table 5 Definition of the Safety Symbols

	Note and follow the instructions for use!
	Before opening the machine, it must be disconnected from the power supply! After disconnecting the machine from the power supply, always wait for at least 2 minutes before opening it.
	Danger! High voltage! If the machine is only switched off at its main switch, dangerous electrical voltage is still present at several terminals in the control cabinet.
	Wear foot protection!
	Wear hand protection!
	Wear eye protection!
	Wear protective clothing!
	Warning! Hot surface!

	Warning! Cold surface!
	ATTENTION!
	Contains pressurised gas!

In particular, the following hazard warnings apply to the machine:

Table 6 Hazard Warnings

	ATTENTION! Work on the chiller must be carried out by properly qualified, competent personnel!
	The surfaces of pipes and components of the refrigerant and cold water circuit and electrical equipment can be very hot during operation and even for a while after.
	The surfaces of pipes and components of the refrigerant and cold water circuit and electrical equipment can be very cold during operation and even for a while after.
	ATTENTION! Pipes and components of the refrigerant and cold water circuit are pressurized.
	ATTENTION! Do not undo the system parts. Risk of injury on contact.
	ATTENTION! Only use the specified liquids!

5.3 Residual Energy

Even if all the hazard warnings in the chapter above are taken into account, the following residual energy situations can result in a hazard:

- Rotational energy of the decelerating fan
 - Despite the installed protective grille, hair or pieces of clothing can still be drawn in and caught.
- Hot surfaces on machine parts

- Especially the compressor head, the hot gas pipe and the condenser can still be very hot for some time after the machine has been switched off. Temperatures from 60 °C to 90 °C are possible.
- Dangerous electrical voltage in the control cabinet despite the switched off main switch
 - If the machine is only switched off at its main switch, dangerous electrical voltage is nonetheless still present at several terminals in the control cabinet. In particular, these are the main supply terminal and the input terminals of the main switch.
- Refrigeration circuit is pressurised
 - Provided it is not damaged the refrigeration circuit is closed. Therefore, a hazard is not to be assumed.

Note:

After switching off the unit at the main switch, please wait 3 minutes before opening the unit, to reduce the risks due to rotational energy and electrical power. In this case only the residual thermal energy must be considered.

5.4 Safety Devices and Safeguards

5.4.1 High Pressure Limiter

The high-pressure limiter is a pressure switch with manual reset. The limiter limits the condensing pressure and switches off all compressors via their load contactors when the maximum permitted system operating pressure is reached. It is part of the safety chain. The limiter is installed on the refrigerant collector. If the limiter has triggered, the chiller will stop with alarm message. In this case, please follow the instructions in the troubleshooting chapter (see **Appendix I**).



Figure 3 High Pressure Limiter Location

5.4.2 High Pressure Monitoring

If the high pressure in the refrigeration circuit of your machine increases to a maximum value, the compressors are switched off via the High-pressure limiter (see **Chapter 5.4.1 High-pressure limiter**). A manual reset is required. The high-pressure monitoring on the other hand reduces the compressor output before the limiter's switch-off value is reached. This is normally done by successive switching off of one or more compressors in order to decrease the system pressure. In most cases partial shutdown of the compressors enables operation of the chiller to be maintained with reduced output.

5.4.3 Low Pressure Monitoring

If the low-pressure in the refrigeration circuit of your system is too low for the specified cooling medium there is a risk of freezing. For this reason, the low pressure is monitored continuously and if it falls below a minimum value, one or more compressors are switched off successively. If the low pressure has increased to a minimum value, the compressors are released once more based on actual load requirement. In most cases partial shutdown of the compressors enables operation of the chiller to be maintained with reduced output.

5.4.4 Flow Monitoring

If the volumetric flow of the cold water which is pumped through the evaporator is too low, there is a risk of freezing. For this reason, the flow through the evaporator is monitored continuously.

If the rate falls below the minimum value of 20 % the compressors are switched off and the message "Flow Alarm" appears. In this case, please follow the instructions in the troubleshooting chapter (see **Appendix I**).

5.4.5 Personal protective equipment when operating the machine

Operating the machine involves making settings at the control panel. During operation of the machine its cladding panels are installed, the machine is completely enclosed. No protective equipment is needed.

We recommend ear protectors be worn by persons with jobs that require them to be continuously in the immediate vicinity of the chiller. Please refer to the sound emission information included in the technical data.

5.5 Personal protective equipment for servicing work

Servicing work on the machine includes all work for which the machine is opened and one or more cladding panels are dismantled. In particular, this includes cleaning work and maintenance work in accordance with **Chapter 10 Service**. Before work is carried out on the chiller the protective equipment described in **Table 5 Definition of the Safety Symbols** must be used.

Table 7 Personal Protective Equipment for Servicing Work

	Wear foot protection!
	Wear hand protection!
	Wear eye protection!
	Wear protective clothing!

5.6 Airborne Sound Emissions

The airborne sound emissions data is given as the sound pressure level, measured at a distance of five metres without reflection. Its maximum value is shown in the technical data. This only occurs at the highest fan speed at the air intake side of the chiller (Figure 5, measuring point [1] and [3]). The emissions in [2] and [4] are generally around 10 % lower than [1] and [3].

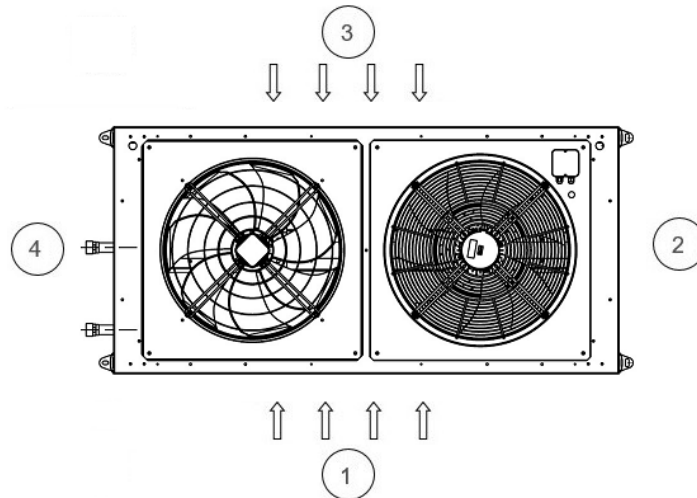

Figure 4 Airborne Sound Emissions

In partial load mode or under favorable ambient conditions (see **Chapter 5.7.1 Noise**) the fan speed and therefore the sound emissions reduce automatically.

5.7 Notes on Reducing Noise and Vibration

5.7.1 Noise

Details of your chiller's airborne sound emissions are given in **Chapter 5.6**.

To reduce noise pollution caused by airborne sound emissions it is advisable to install the chiller outdoor and out of the range of workplaces. If this is not possible we recommend that the air intake side is not pointed directly at a workplace / workstation.

High ambient temperatures mean high fan speeds and this increases the noise levels produced. It is advisable not to expose the chiller to direct sunlight or to install it in rooms with high air temperature. Further information is given in **Chapter 7.2 Installation site**.

5.7.2 Vibration

The chiller frame isolates the vibrations caused by compressors.

5.8 Residual Risks

5.8.1 Electrical



If all safety provisions are complied with there is no risk.

5.8.2 Mechanical



If all safety provisions are complied with there is no risk.

Mechanical damage to components or pipes of the refrigerant circuit can cause refrigerant leaks. Leaking refrigerant can cause cold burns.

5.8.3 Chemical

	ATTENTION! Toxic and caustic products are produced by the thermal decomposition of the refrigerant R410A.
	ATTENTION! Do not install in rooms with open flames or smoke.

5.8.4 Others

	ATTENTION! Risk of suffocation if the chiller is installed in a room that is too small. Please note and follow <i>Chapter 7.2.2</i>.
	ATTENTION! In the EU you must follow the regulation EN378-3. Please also note and follow the local installation regulations and provisions, especially the Ordinance on handling water pollutant substances and BGR500 <i>Chapter 2.35</i>.

5.9 Dangerous Substances

5.9.1 Refrigerant R410A

First aid measures:

- In case of inhalation: remove victim to fresh air, ensuring your own safety, and keep the person at rest in a comfortable position. Get medical attention. If the person stops breathing, give artificial respiration.
- In case of skin contact: leave clothing that has fused with the skin. Rinse areas damaged by cold with lukewarm water (never use hot water). Do not rub! Cover with sterile dressing. Ensure medical treatment is provided.
- In case of eye contact: rinse the eyes with clean water or eyewash solution for at least 15 minutes with the eyelids open. Consult an eye specialist.
- In case of swallowing: swallowing is not considered to be a likely risk as the refrigerant in the surroundings is gaseous.

Notes for the doctor: do not give the patient catecholamine or adrenalin ephedrine preparations.

Fire-fighting measures:

- Suitable extinguishing agents: The product itself does not burn. Match the extinguishing measures to the surrounding fire. Cool containers with Sprayed water.
- Particular hazards due to the substance, its combustion products or gases formed: forms toxic and caustic gases and fumes on decomposition.

- Special protective equipment for fire-fighting: self-contained or air-line breathing apparatus and acid-resistant protective suit for deployment in immediate vicinity. Further information: Fire can cause bursting or explosion of the container. Flammable gas-air mixtures possible under certain conditions.

Measures in case of accidental release:

- Environmental protection measures: the product must not be released into the environment.
- Cleaning procedure: leave the product to evaporate.

Handling and storage:

- Handling: fire and explosion protection: heating results in increased pressure and a risk of bursting. Cool containers at risk with water. Open the containers slowly and carefully.

Personal protective equipment:

- Respiratory protection: not necessary if adequate ventilation available. Self-contained or air-line breathing apparatus within enclosed rooms, if insufficient oxygen supplies available, in case of substantial or uncontrollable release. Only use breathing apparatus in accordance with the international / national standards. Only use breathing apparatus, no filtering devices.
- Hand protection: chemical-resistant protective gloves. Recommended material: Polyvinyl alcohol.
- Eye protection: close-fitting safety glasses/goggles.

General protection and hygiene measures:

- Do not inhale fumes / aerosols.
- Do not eat/drink or smoke during work.

5.9.2 Oil FV68S

First aid measures:

- In case of inhalation: remove victim to fresh air, ensuring your own safety, and keep the person at rest in a comfortable position. Get medical attention.
- In case of skin contact: remove soiled, soaked clothing. Wash skin with water. If symptoms develop, get medical advice.
- In case of eye contact: rinse the eyes with clean water or eyewash solution for at least 10 minutes with the eyelids open. Consult an eye specialist.
- In case of swallowing: can cause vomiting. Have the mouth rinsed out with water and give the patient two glasses of water to drink. Get medical advice.
- Notes for the doctor: symptomatic treatment and assistive therapy as indicated.

Fire-fighting measures: Low fire risk. Product only ignites in case of very large heat supply.

- Suitable extinguishing agents: match to the surroundings. Carbon dioxide, powder and foam extinguishing agents. Use water with caution to avoid possibly considerable steam generation.
- Particular hazards due to the substance, its combustion products or gases formed: irritant fumes are released during thermal decomposition.

- Special protective equipment for fire-fighting: self-contained or air-line breathing apparatus and acid-resistant protective suit for deployment in immediate vicinity.
- Further information: Fire can cause bursting or explosion of the container. Flammable gas-air mixtures possible under certain conditions.

Measures in case of accidental release:

- Environmental protection measures: do not allow the product to enter the sewers or bodies of water. Absorb with sand, soil or a similar absorbent material. Ensure proper disposal in appropriate containers.
- Cleaning procedure: Clean the contaminated area with water. Caution! Slipping hazard!
- Further information: Inform the police or competent authorities in case of leakage into the sewers or bodies of water.

Personal protective equipment:

- Respiratory protection: Not necessary if adequate ventilation available. Self-contained or air-line breathing apparatus within enclosed rooms, if insufficient oxygen supplies available, or in case of substantial or uncontrollable release. Only use breathing apparatus in accordance with the international / national standards. Only use breathing apparatus, no filtering devices.
- Hand protection: protective gloves. Recommended material: nitrile rubber.
- Eye protection: close-fitting safety glasses/goggles.

Handling and storage:

- Handling: avoid lengthy skin contact. Avoid inhaling high concentrations of vapor or fumes.
- Storage: suitable material for containers: mild steel. Tightly close unused containers to prevent the penetration of moisture. Store away from strong oxidants.

5.10 Reasonably Foreseeable Misuse

Reasonably foreseeable misuse, for the users of the chiller, means foreseeable use in a way not intended according to the operating instructions. It is due to foreseeable human error.

The following dangerous situations can arise due to misuse which could reasonably be expected:

- dangerous voltage of electrical components, if the machine is not disconnected from the power supply before it is opened.
- the fan and compressor can start up suddenly, without any visible change to the machine's state.
- even if the machine has been disconnected from the power supply, the surfaces of components in the unit can still be very hot or cold.
- risk of damage to external hydraulic components if the cold-water feed is confused with the cold water return.
- danger caused by using media in the unit that have not been approved.
- danger caused by connecting an incorrect source of power.

5.11 Information for Emergencies

If an emergency occurs during operation of the chiller the machine must be disconnected from the mains at once using the master switch. Remove people from

the danger zone immediately. An emergency situation can among other things be:

- o a leak and escape of refrigerant and/ or oil.
- o a part of the machine becoming mechanically detached from it.
- o the machine making unusual noises.
- o the machine vibrating severely.

Then contact the KKT chillers service team. If you detect a refrigerant or oil leak, proceed as described in ***Chapter 5.9 Dangerous substances***.

6 Handling and Storage

The chiller is fixed on a wooden pallet in the factory for delivery. The machine is additionally protected against damage by polystyrene corner protectors and stretch film. Therefore, you should remove the packaging as late as possible.

6.1 Transport

The chiller may only be transported using a fork lift truck or crane with sufficient rated capacity. The net weight of your machine is given in the technical data. Please note that if a machine has already been in operation, it can contain residual fluids, which increase the transport weight.

	<p>ATTENTION! The chiller must not be tilted by more than 10° from the perpendicular position.</p>
---	---

6.1.1 Forklift Truck

It is possible to transport the machine both in a packed and an unpacked condition by means of fork lift truck. In this case, please note the defined center of gravity marking as shown below.

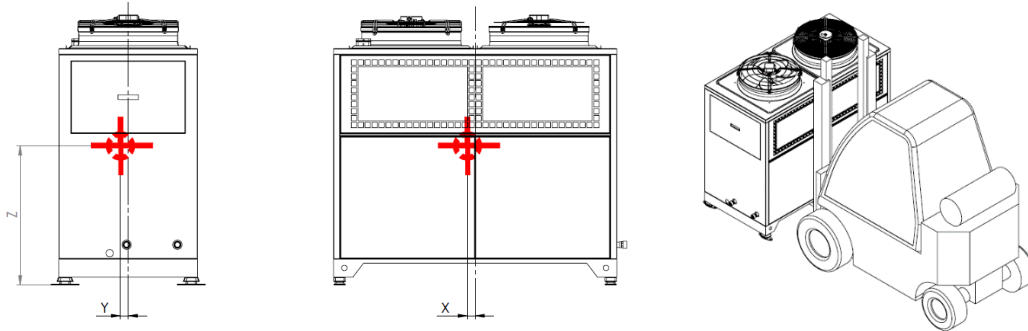

Figure 5 OCLC MED Center of Gravity

Table 8 Center of Gravity

Unit Model	X(mm)	Y(mm)	Z(mm)
OCLC MED 25	20	30	900
OCLC MED 50	20	30	900
OCLC MED 70	30	50	900

6.1.2 Crane

When it is unpacked the machine can be lifted by means of a crane and an adequately dimensioned lifting beam. Transport sling is recommended, chains not allowed.

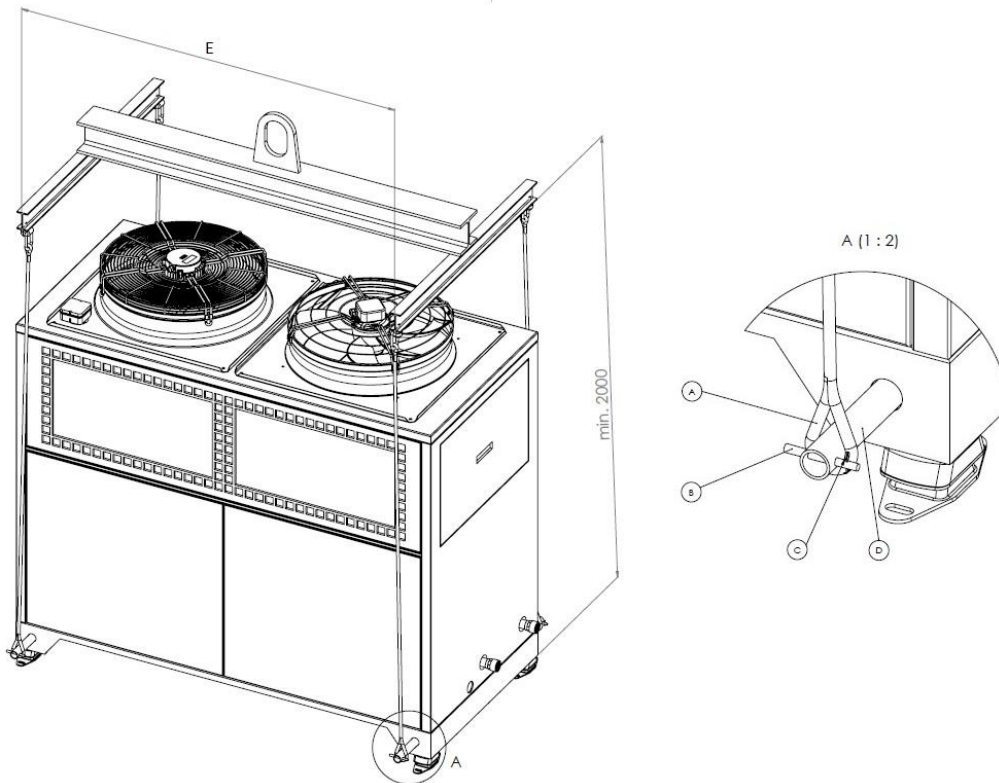



Figure 6 OCLC MED Crane Transport

Table 9 Description of Crane Transport

A	Strap or rope (do not use metal rope)
B	Locking pin
C	Split pins
D	Pipe diameter: 30 - 50 mm. Wall thickness: min.3 mm. Length:1200 mm
E	830 - 1650 mm







6.2 Unpacking

	<p>ATTENTION! Packing straps are mechanically stressed and can snap back when cut. Risk of injuries!</p>
---	---

Remove all straps, films, corner protectors and spacers carefully. Optional accessories may be located under the film. Ensure that they are not damaged.

The packaging can be recycled according to the local regulations. Refer to the following table for details of the packaging materials used:

Table 10 Materials in the Packaging

Element	Material	Recycling Code
Polystyrene corner protectors	Polystyrene	
Stretch film	Polyethylene	
Edge protection / corner protectors	Cardboard	
Packaging tape	Polypropylene	
Strapping seals	Zinc-plated steel	
Wooden pallet	Untreated raw wood, spruce or pine without bark	

6.3 Storage

If the chiller is stored for more than one month, it should remain in the transport packaging or be repacked.

The following conditions must be noted for storage:

- Avoid direct sunlight and moisture
- Ambient temperature – 30 °C to + 50 °C

To avoid frost damage, the cold water circuit must be completely drained before the chiller is placed in storage and then flushed with a mixture of water and anti-freeze (see **Chapter 11 Taking Out of Service**).

7 Installation

7.1 Overview

Several tasks are necessary to install the chiller. The following work schedule shows the order in which they are carried out:

- Prepare the installation site
- Install the machine
- Flush the cold water circuit
- Hydraulic installation
- Fill the whole system
- Vent the whole system
- Electrical installation

7.2 Installation Site

7.2.1 General Information

The chiller is suitable for both indoor and outdoor installation (note options packages). The electrical degree of protection corresponds to IP54. If installed indoors, ensure sufficient air exchange. An enclosed room will steadily heat up and the machine can switch off due to a lack of cooling. The exhaust heat from the machine can be approximately calculated as 1.3 x net refrigeration capacity. The air flow rate required for your machine is given in **Chapter 1.2 Technical data**. When choosing the installation site, ensure that air intake side of the chiller is protected from waste heat produced by other processes.



ATTENTION! Do not install in rooms with open flames or smoke.

7.2.2 Minimum Room Volume

The refrigerant R410A contained in the system is classified in safety group A1 in accordance with EN 378-1 Table E.2. That means the refrigerant is not flammable and has low toxicity. If the chiller is installed in enclosed rooms without additional safety measures a minimum room volume is required. This is due to the maximum concentration occurring in an area occupied by persons in the event of release and depends on the refrigerant quantity in the chiller. Please refer to the following table for the value to be complied with for your machine.

Table 11 Minimum Volume of the Installation Room with regard to Maximum Refrigerant Concentration in case of a Leakage if installed indoors

OCLC MED chiller	25	50	70
Minimum Free Volume (in m ³)	12	15.3	23.5

7.2.3 Ambient Temperature

The chiller is cooled by the ambient air and the lower the temperature of this cooling air the more economically the chiller works. Direct sunshine or exhaust air from other machines heats up the surrounding air and must be taken into account when installing the chiller. Preference is for a shaded installation. The maximum ambient temperature is given in the technical data.

7.2.4 Effect of Surrounding Air Flow

The chiller emits heat to the surrounding area, the machine also draws in cooling air. The machine controls the quantity of cooling air automatically via the speed of the fan. Air currents surrounding the machine, such as the wind, can affect this control and endanger operation of the machine. If a constant direction of an air current is known at the installation site, this should not be directed at the air intake side of the chiller.

7.2.5 Minimum Clearances

The minimum clearances around the machine are made up of service clearances and clearances to ensure optimum air supply. On the one hand accessibility must be ensured from all sides, in addition, an unhindered, sufficient quantity of cooling air must be able to be drawn in and blown out upwards. If the minimum clearances are not complied with, there is a risk of an air short-circuit between the air intake and discharge side. As regards to the minimum clearances please refer to figure below.

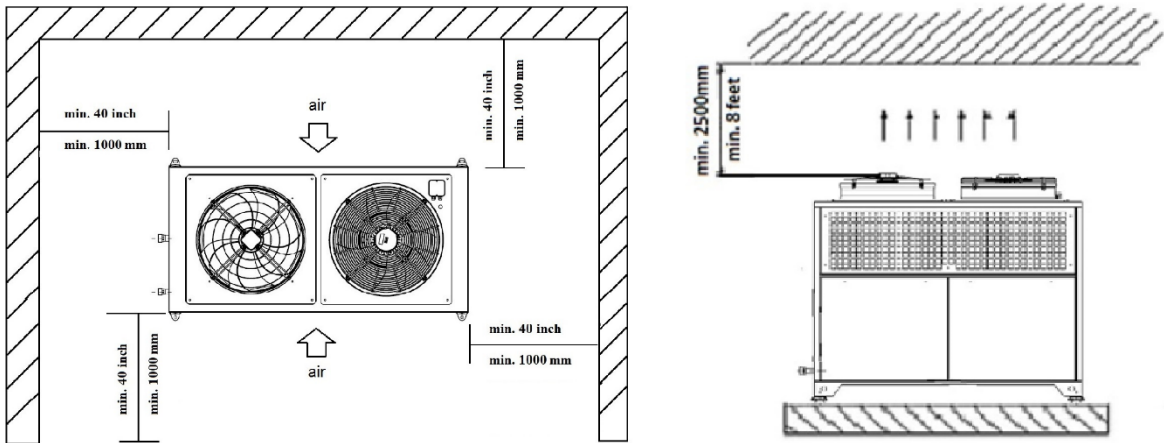

Figure 7 Minimum Clearances Around

7.2.6 Surface and Foundation

The surface on which the machine is installed must be flat and horizontal. All the machine's feet must have steady contact with the ground. Ensure that the ground / subsoil has sufficient load bearing capacity. According to **Table 12** a continuous concrete foundation with the given minimum size is recommended. The installation could refer to **Figure 8**. For details, the gross weight of your machine is listed in **Chapter 1.2 Technical Data**.

If it is not possible to lay a foundation, the machine can also be positioned on a base frame made of steel sections. Please also ensure here that all the unit feet have steady contact with the base frame.

Table 12 Minimum size for concrete foundation

OCLC MED Chiller	25	50	70
Minimum Size L*W*H (in mm)	2040*1100*200	2040*1100*200	2350*1300*200

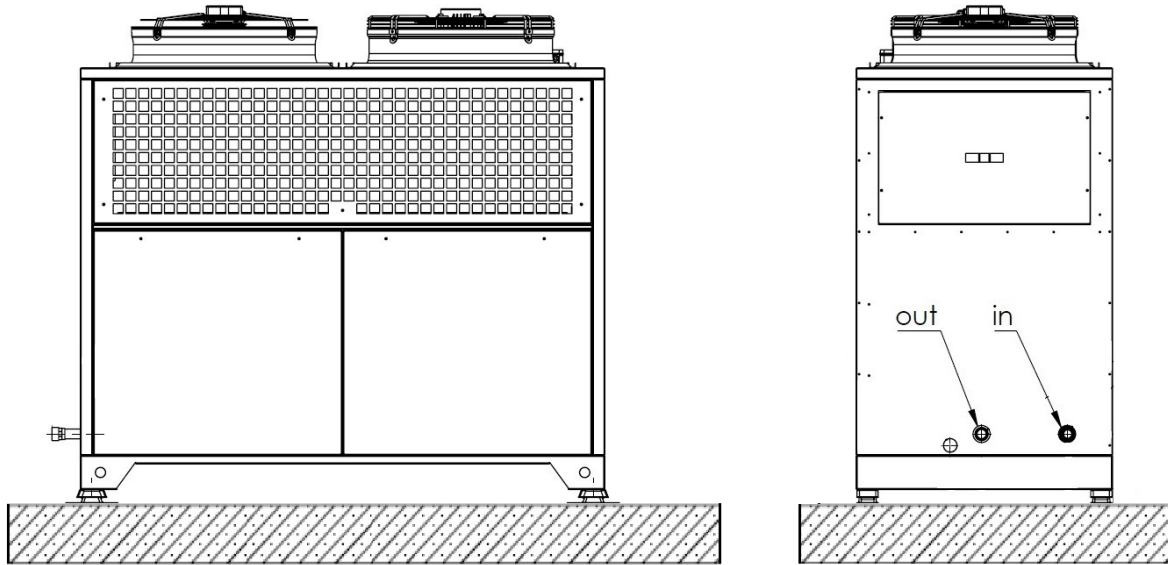

Figure 8 Installation on Concrete Foundation

7.2.7 Installation

	Filling and Feed (Topping Up)
	Draining
	Unit Outlet Cold Water (Supply)
	Unit Inlet Cold Water (Return)

7.2.8 Hydraulic Installation

The system designer is responsible for choosing the material and the cross-section of the hydraulic connections between the chiller and the application. Other dependent factors include the accepted pressure loss in the connection lines and the available pump pressure. When designing the connections attention must also be paid to the minimum flow rate to be maintained and sufficient resistance to the maximum pump pressure.

	<p>ATTENTION! Galvanized pipes must not be used if water-glycol mixtures are used! Formation of decomposition products, which result in silting up of the system!</p>
--	--

7.2.9 Frost Protection Measures



The machine must be protected against freezing by antifreeze in accordance with the specifications. Please note that the evaporation temperature is always significantly below the cold water flow temperature. Even within the supposed safe temperature range there can still be a risk of freezing. Ensure that you comply with the requirements with regard to the operating fluid and the mix ratio.

7.2.10 Flushing the Cold Water Circuit

Contamination of external pipes and components can damage the chiller. Before the chiller is connected hydraulically with the cold water circuit this must be flushed several times. If there are dirt traps in the cold water circuit they must be cleaned after the flushing.

7.2.11 Filling



If the hydraulic installation of the overall system has been completed the chiller can be filled. All shut-off valves in the cold water circuit must be opened.

	<p>ATTENTION! Only use approved coolant, see <i>Chapter 2.5!</i> If there is a risk of frost, note <i>Chapter 7.2.9!</i> All operating liquids must be mixed before they are added to the system!</p>
	<p>ATTENTION! In the EU you must follow the regulation EN378-3. Please also note and follow the local installation regulations and provisions, especially the Ordinance on handling water pollutant substances and BGR500 <i>Chapter 2.35.</i></p>

7.2.12 Venting

When chiller is installed onsite, we recommend installing an automatic venting valve at the highest point in the cold water circuit.

7.2.13 Electrical Installation

	ATTENTION! The electrical installation, testing and commissioning may only be carried out by qualified personnel. Note and follow the local regulations.
	ATTENTION! Do not switch on the chiller until the hydraulic installation is completed and the machine has been filled as specified in <i>Chapter 7.2.11</i> . Otherwise the machine could be damaged.

The chiller is connected electrically to its main supply terminal in the control cabinet (see *Figure 9 Main Supply*). A circuit diagram is supplied with the unit.

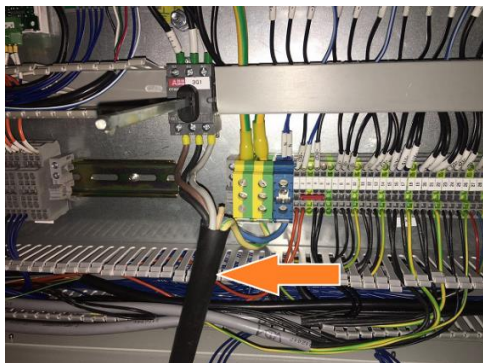

Figure 9 Main Supply

The dimensioning of the load cable and the fusing must be in accordance with the machine's technical data and the local regulations of the power supply company.

Never switch on the chiller immediately if the machine is moved from a cold into a warm room. The condensing moisture can damage electronic components. For the initial startup or following a lengthy period out of use, all the electronic components must be acclimatized.

Use an external control cable to set the chiller's release (see *Chapter 9.3 External release*); this cable is laid parallel with the supply cable and is wired at the corresponding terminals in the control cabinet. The machine is bridged at the corresponding terminals on delivery.

After the electrical installation has been completed the phase sequence must be tested. This is done by checking the rotational direction of the pump or fan. The correct air flow direction is upward. If the rotational direction does not match, the phase sequence can be corrected by switching two phases at the main supply. Detailed phase sequence check process please refer to *Chapter 9.7 Phase Sequence Check Process*.

7.2.14 Grounding

The basic countermeasures are isolation of the wiring of control and power components, proper grounding and shielding of cables. A large contact area is necessary for low-impedance grounding of HF interference. The use of grounding straps instead of cables is therefore definitely advisable. The cable shields must be connected with purpose-made ground clips. The grounding surface must be highly conductive bare metal. Remove any coats of varnish and paint.

The width of the grounding wire must follow local regulation, and be at least the same width of the power supply. The grounding must be an isolated ground (refer to Figure 11) and must be connected on the ground terminal in the switch cabinet. The ground resistance must be less than 5 ohm.

Metal cable conduits are not allowed for grounding. The piping of the chiller (supply and return) has to be grounded too.

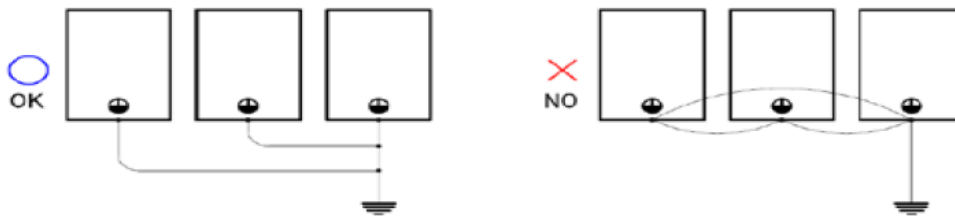

Figure 10 Grounding

8 Commissioning

Before commissioning the chiller, the checklist must be used to check whether all the necessary work in **Chapter 7 Installation** has been carried out properly.

The chiller must be installed for at least 12 hours at $>+5\text{ }^{\circ}\text{C}$, so that the compressor oil can heat up and the refrigerant can be liberated from the oil.

If your machine is equipped with oil sump heating and the machine has been completely installed, it is permissible to switch on the machine at the main switch and to allow the compressor to be preheated for at least 5 hours without enabling the cooling.

8.1 Installation Checklist

- Unit installed horizontal and stable?
- Any vibration damping and floor anchors installed?
- Spaces / clearances around the unit are adequate according to the requirements?
- Air intake side free from packaging materials, etc.?
- Hydraulic connection OK?
- Cold water circuit filled in accordance with the specifications? Water quality OK?
- Whole system flushed? Strainer cleaned?
- Cross-sections adequately dimensioned?
- Are the settings of the motor circuit breaker are adjusted to the circuit diagram?
- Electrical connection OK? Electrical power is available?
- External pumps OK? Rotational direction?
- Unit cover closed?
- Overall system OK and ready for commissioning/start-up?
- Compressor "preheated"?
- External enable OK?
- Is the integrated transformer connected to the customer power supply (50Hz/60Hz)?
for 60Hz: OCLC MED 25
for 50 Hz OCLC MED 25 (factory wiring)



After checking the above list, you can continue with **Chapter 9 Operation**.

9 Operation

The chiller is designed for fully automatic operation.

9.1 Switching On

First, switch on the machine at the main switch. The start screen appears on the display.

9.2 Selecting the Operating Mode

In the Start screen you can choose between the following three operating modes:

- OFF
If you select "OFF" mode, all electrical components except the compressor heater are switched off.
This operating mode is to be selected if the chiller was disconnected from the power supply in ambient temperatures $<5^{\circ}\text{C}$ for longer than 6 h. In this case the compressors must be preheated for 5 h, so that the refrigerant can escape from the oil.
- AUTO
With the selection of "AUTO" operating mode the machine is ready for use. The fully automatic operation only starts in this mode if the external release has been installed beforehand as described in **Chapter 9.3 External release**.
- ON
Fully automatic operation (without external release) starts with the selection of "ON" mode.

9.3 External Release

An external control cable can be wired up in place of the bridge. Fully automatic operation starts with this external release.

9.4 Control

The chiller's control consists of a control board and a control panel, which communicate with each other. The control board operates independently so that if the control panel or communication fails, chiller will still work if no other fault prevents operation.

9.5 Control Panel

The following figure shows the chiller's display and control elements.



Figure 11 Display and Control Elements

Table 13 Description of Display

Number	Function
1	Turn to front page, or Modify the values
2	Switch the variable value, confirm and continue
3	Turn to next page, or Modify the values
4	Return to former page
5	Turn to main menu
6	Show current alarm, or Manual reset

9.5.1 Start Screen

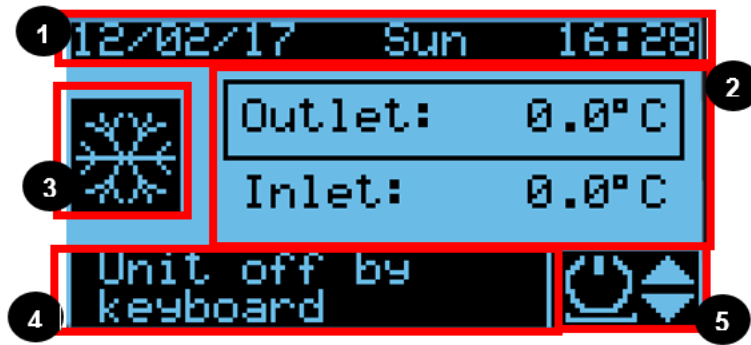

Figure 12 Start Screen while OFF Mode

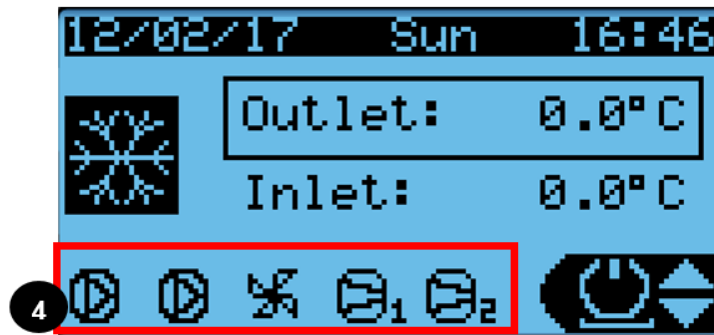

Figure 13 Start Screen while ON mode

The general operating state of the chiller is displayed on the start screen:

1. Date and time
2. Inlet and outlet water temperature, the one in black frame is control target.
3. Cooling or Heating
4. Words show that chiller is OFF. If chiller is ON, it will show the status of pumps, fans and compressors. Icon filled in black means the component is running.
5. Customer menu (Quick menu). Customer can select by UP and DOWN button, press ENTER to next page to check the detailed information, status or setting points.

9.5.2 Customer Menu

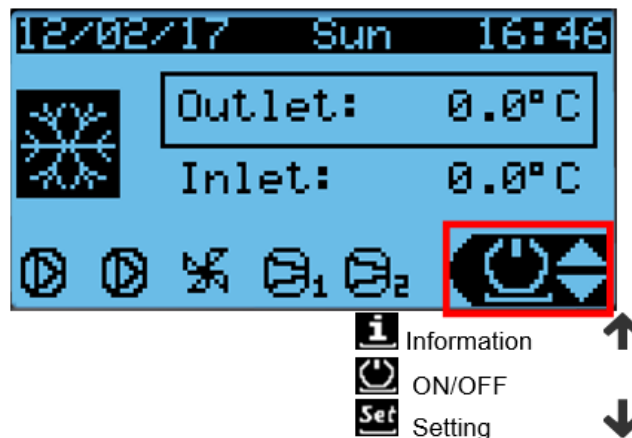

Figure 14 Customer Menu

Use the UP and DOWN button to select on start screen, press ENTER to next page for details. No password is needed for this menu.

9.5.3 Information

The menu here contains all basic information, including chiller status, EEV status and open degree, input/output status, equipment working hours, software code and versions, controller status.

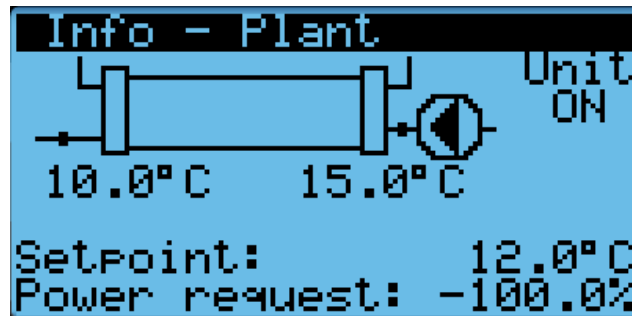

Figure 15 Chiller Status

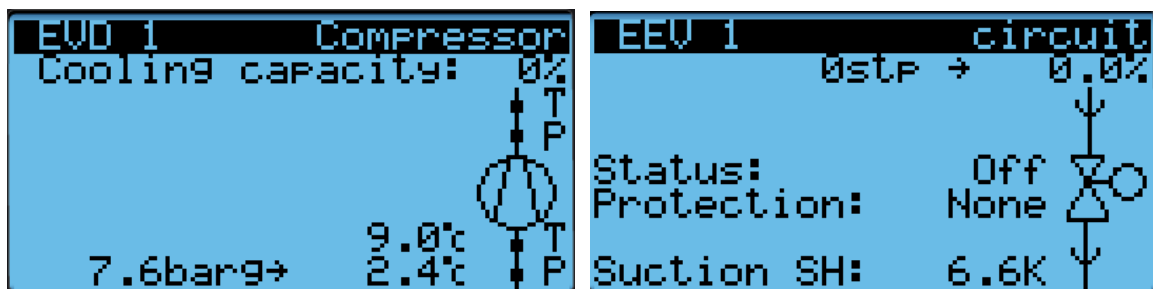

Figure 16 EEV Status

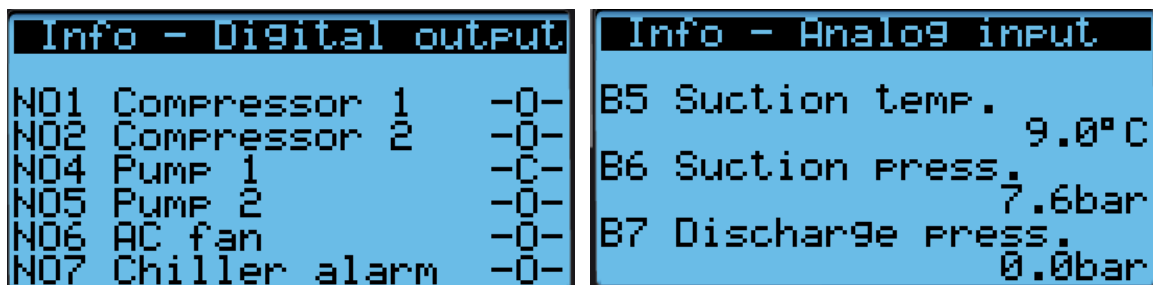

Figure 17 Input/Output Status

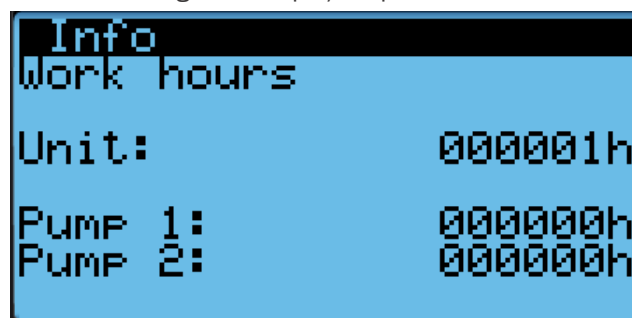

Figure 18 Equipment Working Hours

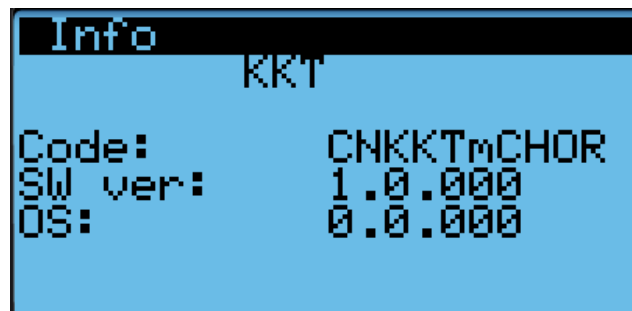

Figure 19 Software Code and Versions

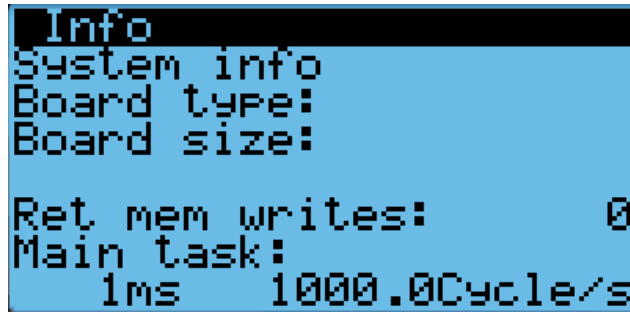

Figure 20 Controller Status

9.5.4 Start/Stop

Customer can start or stop the chiller on this page, or check running mode here.

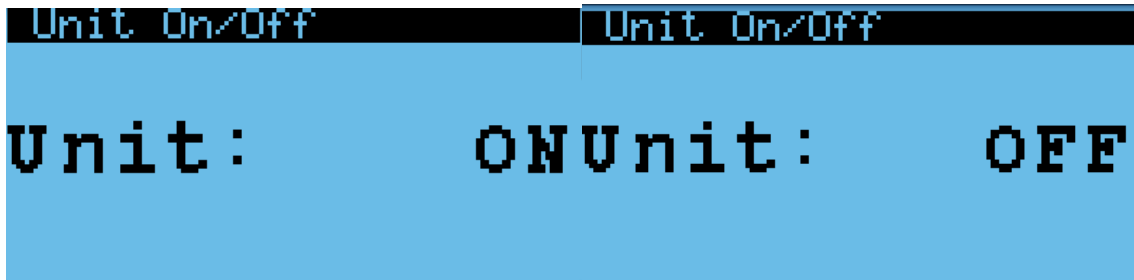

Figure 21 Chiller Running Mode

9.5.5 Setting Points

Customer can change the setting points of outlet water temperature or hysteresis in this menu.

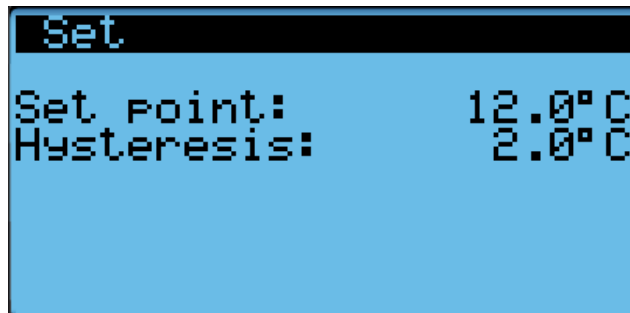

Figure 22 Water Temperature Setting Points

9.5.6 Alarm Menu

Press “Alarm” button (button 6 in *Figure 11*) to access alarm menu. You can check current alarms here. The service engineer should perform troubleshooting according to the alarm information, after that, press “Alarm” button for longer than 3 seconds to clear the alarms. Chiller will run automatically afterwards.



Figure 23 Alarm Menu

9.6 Controller Description

9.6.1 Chiller Start and Stop

The following conditions must be fulfilled before chiller start from standby status:

- The control has finished its initialization routine
- Pump start and no flow alarm
- The inlet or outlet water temperature sensor works well
- Setting point is lower than actual outlet water temperature (supply temperature)
- Chiller has no group/system level alarm

The pump will start when below conditions are fulfilled:

- Chiller running mode is “ON” or received start signal under “AUTO” mode
- The inlet or outlet water temperature sensor works well
- The inlet water temperature (return temperature) is in allowed range
- Chiller has no group/system level alarm

The condenser fan will start when below conditions are fulfilled:

- System pressure is higher than setting point
- Chiller receives water temperature control request
- Chiller has no group/system level alarm

From the standby state, a software switch in the display can be used to switch the chiller between OFF-AUTO-ON. When chiller switches to start status, the pump will start first, while the water temperature control will start 10s later.

The pressure and flow monitoring take place with two timing elements:

- Delay at start; the pressure or the flow monitoring does not trigger an alarm.
- Delay during operation; in order to ignore short-term fluctuations in pressure or flow, the alarm is delayed.

When the system is switched off the temperature control is locked immediately and therefore the compressor is switched off. The pump continues running to prevent uncontrolled continued evaporation.

9.6.2 Water Temperature Control

In the normal case the outlet water temperature (supply temperature) sensor will be used for load control. If this sensor fails, the control switches internally to the inlet water temperature (return temperature) sensor and the target value (setting point value) is increased by a defined value.

A purely proportional controller is used, which generates an output signal from -100 % to + 100 %. Single compressor matches 50% load. The percent of load control is based on the temperature difference between actual supply temperature and setting point.

There will be an unload request to chiller under below condition:

- High pressure warning
- Low pressure warning

9.6.3 Compressor Control

The compressors are requested depending on the controller output signal. The compressor with the least number of operating hours switches on first. If no more refrigerating capacity is required,

the compressor running longer time will switch off first. There is minimum time period limit for compressors switching between start and stop.

The high pressure is monitored on the hardware side by means of the high-pressure limiter. If it is triggered all compressors switch off immediately. In addition, the high pressure is controlled by means of a pressure transmitter. This also switches off the compressors if the setting point is exceeded, but releases them again if the value falls below the release value. Before switching off the high-pressure transmitter signals a warning.

Low pressure is also monitored by pressure transmitters. If the value falls below the setting point the compressors switch off. If the switch-off value is exceeded by the hysteresis, the compressors are released again. The triggering of the alarm is delayed by two timing elements. The first timing element is started with the request for the compressor. If no intake pressure has built up by the time the time expires the low-pressure fault alarm is triggered. After the start time has expired the low pressure may exceed the switch-off value for a short time. If this occurs more than three times within an hour the compressors are blocked. Before a low-pressure fault is triggered a low-pressure warning will be shown first.

9.6.4 Fan Speed Control

Due to the continuous adjustment of the fan speed, the condensing pressure is kept constant depending on the ambient temperature by means of a PI controller.

9.6.5 Electronic Expansion Valve Control

An electronic expansion valve with PI controller is used to keep the super heat constant. To protect the compressor for a safe running, there are also maximum operating pressure (MOP) and low pressure (LP) limit function in the controller.

9.6.6 Temperature Limit Monitoring

The return water temperature is monitored for a maximum limit value if the chiller is switched on (pump is running). If the limit value is exceeded, an alarm is triggered with time delay, which switches off the chiller.

9.6.7 Alarm Message

When an alarm occurs, chiller will show the alarm message in the alarm menu. Customer or service engineer should perform troubleshooting according to the alarm information, so chiller can work well again.

9.7 Phase Sequence Check Process

To ensure chiller runs well and there is no reverse rotation of the main components like compressor, the phase sequence of supply wirings should be checked before starting the chiller. You could select either one of below methods for this check:

- 1) Use phase-sequence meter to check.
- 2) Manual start the AC fan to check the sequence according to the air flow direction. Steps as below:
 - a) Switch ON all circuit breakers in the electrical cabinet to avoid “Fan MPCB Error” or other alarms.
 - b) Switch chiller’s running mode to “OFF” on display, press button  to access the main control menu. Change the status of AC fan from “Auto” to “manual ON” through “Unit config” menu. Check the air flow direction (correct direction is upward) to clarify if the phase sequence is correct. If the air flow direction is wrong, then change the AC fan status back to “Auto”. Shut down the power, and re-connect the supply wiring to get the correct phase sequence.

10 Service

All service work may only be carried out by properly trained, competent personnel.

10.1 Maintenance

Reliable operation and a long service life for the entire system can be guaranteed by proper maintenance.

The purpose of the maintenance is:

- to ensure that the machine operates reliably and without unexpected failures
- to plan further service work in order to minimise downtimes

An overview of the maintenance intervals as recommended by the VDMA is given in **Appendix II**. In addition, the national regulations of the respective installation site must be followed.

Please note that the points listed represent the minimum maintenance required. By increased monitoring, system reliability can be enhanced. Please contact our service department at any time about maintenance quotations / service agreements.

10.2 Fault Correction

Troubleshooting and fault correction instructions are given in **Appendix I**.

Our technical customer service can be reached around the clock and will assist you with all service matters (maintenance, repairs, spare parts, etc.):

Europe Service Team

T: +49 9228 9977 7190

E: service@kkt-chillers.com

W: www.kkt-chillers.com

USA Service Team

T: +1 833 558 4357

E: techsupport@kkt-chillersusa.com

W: www.kkt-chillersusa.com

China Service Team

T: +86 400 928 9655

E: service@kkt-chillerscn.com



10.3 Spare Parts

To ensure that the performance of your chiller is not impaired, we recommend that you only use original spare parts purchased from KKT chillers. In this way you ensure the reliability and quality of the machine. If you have any questions about spare parts, please contact our KKT chillers Service Team (**Table 1 Contact Details**).

11 Taking Out of Service

	<p>ATTENTION! Decommissioning must only be carried out by professional and qualified technicians. They must also be familiar with the local regulations.</p>
---	---

For safety-relevant instructions regarding possible residual energy, please refer to **Chapter 5.3 Residual Energy**.

If the system is filled and there is a risk of frost, suitable measures must be taken to protect the liquid from frost. The complete cold water circuit must be fully drained before any lengthy stoppage of the unit. Do this as follows:

1. Drain the evaporator via the drain cock provided
2. Drain the pump using the drain plug provided

The drain cock is marked on the unit by the symbol in below figure.

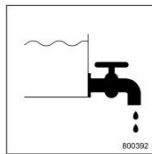
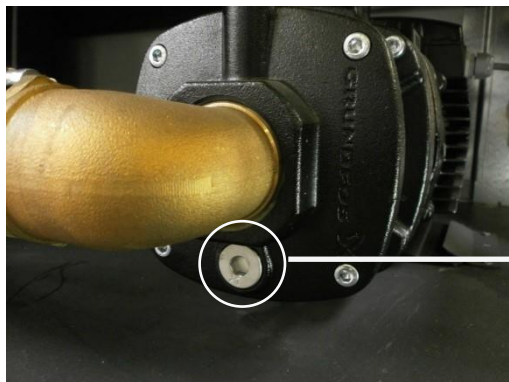

Figure 24 Drain Cock

The position of the drain plug is shown in below figure:



Drain Plug
(Allen key 10 mm)

Figure 25 Position of the Pump Drainage

To prevent frost damage, the cold water circuit must be flushed with a mixture of water and ethylene glycol (35% concentration).

12 Recycling

	<p>ATTENTION! Dismantling must be carried out by professional and qualified technicians.</p> <p>Water and refrigerant pipes are pressurized!</p> <p>They must also be familiar with the local regulations.</p>
---	---

All parts (e.g. refrigerant, oil, glycol, metal, electronics, battery etc.) must be recycled, reused or disposed of. Please note and follow all local and national regulations and if necessary contact your local waste management agency.

A specialized disposal company must be contracted to dispose of these wastes. They issue a proof of disposal which must be archived. The chiller can be returned to KKT chillers for disposal. Please contact our KKT chillers Service Team for details (***Table 1 Contact Details***).

13 Products, Solutions and Services

Apart from the OCLC MED, KKT chillers also offers other products, solutions and services which are not described in this document. For more information, visit our homepage <http://www.kkt-chillers.com> or contact your KKT chillers contact (**Table 1 Contact Details**)– We look forward to hearing from you!

14 Lists

14.1 List of Illustrations

Figure 1 Refrigerant Diagram	11
Figure 2 Control Cabinet Cover.....	14
Figure 3 High Pressure Limiter Location.....	21
Figure 4 Airborne Sound Emissions	23
Figure 5 OCLC MED Center of Gravity	28
Figure 6 OCLC MED Crane Transport.....	29
Figure 7 Minimum Clearances Around	32
Figure 8 Installation on Concrete Foundation	33
Figure 9 Main Supply	35
Figure 10 Grounding	36
Figure 11 Display and Control Elements	39
Figure 12 Start Screen while OFF Mode	40
Figure 13 Start Screen while ON mode.....	40
Figure 14 Customer Menu	40
Figure 15 Chiller Status	41
Figure 16 EEV Status	41
Figure 17 Input/Output Status	41
Figure 18 Equipment Working Hours.....	41
Figure 19 Software Code and Versions	41
Figure 20 Controller Status.....	42
Figure 21 Chiller Running Mode.....	42
Figure 22 Water Temperature Setting Points.....	42
Figure 23 Alarm Menu	42
Figure 24 Drain Cock	47
Figure 25 Position of the Pump Drainage.....	47

14.2 List of Tables

Table 1 Contact Details..... 1

Table 2 Safety Instructions 6

Table 3 Explanation of Terms10

Table 4 Water Quality.....15

Table 5 Definition of the Safety Symbols.....19

Table 6 Hazard Warnings.....20

Table 7 Personal Protective Equipment for Servicing Work22

Table 8 Center of Gravity28

Table 9 Description of Crane Transport.....29

Table 10 Materials in the Packaging30

Table 11 Minimum Volume of the Installation Room with regard to Maximum Refrigerant Concentration in case of a Leakage if installed indoors.....31

Table 12 Minimum size for concrete foundation32

Table 13 Description of Display.....39

I. Troubleshooting

Code	Fault	Fault Description	Type of Failure	Fault Cause	Fault Correction
593	Write max time memory	Error in the number of retain memory writings	warning	Default of Controller	Contact KKT Service
594	Write memory fail	Error in retain memory writings	warning	Default of Controller	Contact KKT Service
501	AI coldwater temp inlet (VP)	B8-Inlet water temperature probe error or offline	warning	Sensor short-circuit or break	Testing the supply cable / connector / sensor
502	AI coldwater temp outlet	B9-Outlet water temperature probe error or offline	error	Sensor short-circuit or break	Testing the supply cable / connector / sensor
523	AI suction gas temp	B5-Suction temperature probe error or offline	error	Sensor short-circuit or break	Testing the supply cable / connector / sensor
522	AI low pressure	B6-Suction pressure probe error or offline	error	Sensor short-circuit or break	Testing the supply cable / connector / sensor
521	AI high pressure	B7-Discharge pressure probe error or offline	error	Sensor short-circuit or break	Testing the supply cable / connector / sensor
621	DI compressor 1 mpcb	ID1-Compressor 1 alarm	error	Compressor 1 motor protection has triggered. Motor current is outside the permitted range	Check compressor 1: Check supply cable! Compressor blocked? Current measurement of individual phases? Continuity measurement of the windings? Load contactor is not working correctly.
622	DI compressor 2 mpcb	ID2-Compressor 2 alarm	error	Compressor 2 motor protection has triggered. Motor current is outside the permitted range.	Check compressor 2: Check supply cable! Compressor blocked? Current measurement of individual phases? Continuity measurement of the windings? Load contactor is not working correctly
161	LP STOP	Low suction pressure alarm	error	The low-pressure of the refrigeration circuit is within the critical range for the system configuration: Liquid flow through the evaporator is too low; Refrigerant loss; Faulty function of the expansion valve; Faulty function of the LP sensor.	Check liquid flow. Check the function of the expansion valve. Check loss of refrigeration.
627	DI HP delimiter	B3-High pressure switch alarm	error	High-pressure alarm has triggered, the pressure on the high-pressure side of the refrigerant cycle has risen very quickly above the max. value of 45 bar.	Are all metal cladding panels in place? Check condenser for external contamination! Is the ambient temperature within specification? Can you exclude an air short-circuit? Can you exclude strong sunlight radiation? Can the cooling air flow unhindered into / out of the machine?
632	DI fan 1 error	B1-AC Fan internal alarm	error	Internal monitoring of the fan has output fault	Check the fan wiring. Fan blocked? Missing phase? Fan overload?

634	DI fan 2 error	B2-EC Fan internal alarm	error	Internal monitoring of the fan has output fault	Check the fan wiring. Fan blocked? Missing phase? Fan overload?
611	DI pump 1 mpcb	ID3_Pump 1 alarm	error	Pump 1 motor protection has triggered. Motor current is outside the permitted range	Check Pump 1 MPCB, short-circuit in the supply cable? Internal short-circuit in the motor windings? Motor blocked? Load contactor is not working correctly
615	DI pump 2 mpcb	ID4_Pump 2 alarm	error	Pump 2 motor protection has triggered. Motor current is outside the permitted range	Check Pump 2 MPCB, short-circuit in the supply cable? Internal short-circuit in the motor windings? Motor blocked? Load contactor is not working correctly
631	DI fan 1 mpcb	ID5_AC Fan alarm	error	AC Fan motor protection has triggered. Motor current is outside the permitted range	Check AC fan: Check supply cable! Fan blocked? Current measurement of individual phases? Load contactor is not working correctly
633	DI fan 2 mpcb	ID6_EC Fan alarm	error	EC Fan motor protection has triggered. Motor current is outside the permitted range	Check EC fan: Check supply cable! Fan blocked? Current measurement of individual phases?
610	Pump group flow switch alert	Flow switch alarm	error	The flow switch signal cannot be created when pump is running. External gate valve closed, Filter dirty, air in the system.	Open external gate valve, clean filter, vent the system. Check the function of pump and flow switch.
391	Pump group fault (Redundanzsystem)	Pump group fault	error	Both Pump 1 and Pump 2 is not available because of MPCB trip	Check both pump 1 and pump 2 the same as MPCB trip
173	EEV Superheat min STOP	Low suction gas superheat	error	The superheating value has fallen below the minimum limit	Reset automatically
182	EEV MOP	The maximum allowable evaporation pressure (MOP) has been exceeded	warning	Evaporation temperature too high	Reset automatically
183	EEV suction gas temp. Min	Suction gas temperature too low	error	The suction gas temperature has fallen below the minimum allowable value	Reset automatically
189	EEV collective fault	An error has occurred at the expansion valve	error	one or several messages in relation to the expansion valve (EEV) has/have occurred	Reset automatically
188	EEV emergency close	EEV emergency close	error	EEV emergency close	Reset automatically
341	Warning Operating hours DO pump 1	Pump 1 working hour warning	warning	The maximum allowable Pump 1 working hour has been exceeded	Maintenance require
342	Warning Operating hours DO pump 2	Pump 2 working hour warning	warning	The maximum allowable Pump 2 working hour has been exceeded	Maintenance require

303	Inlettemp. max warning	Capacity not enough warning	warning	Cold water temperature cannot reach target setting	Check heat source and chiller cooling capacity. Check evaporator function
355	Inlettemp. max STOP	High inlet water temperature alarm	error	The maximum allowable temperature of return water exceeded	Check heat source or ambient temperature too high
303	Inlettemp. max warning	High inlet water temperature warning	warning	The maximum allowable temperature of return water warning exceeded	Check heat source or ambient temperature too high
132	EEV Superheat max warning	High suction super heat alarm	warning	The maximum allowable suction superheat has been exceeded	Return water temperature too high. Loss of refrigeration. Heat source too much

II. Maintenance intervals in accordance with the VDMA

Items	Explanation	Annual	semi anual	as required	Remark
	Compressor				
1	Optical check for dirt, damage and corrosion	x		x	
2	Check fixing, check running noises	x			
3	Measure the intake pressure	x			
4	Measure the suction gas temperature upstream of the compressor	x			
5	Measure the compression end temperature at the discharge port	x			
6	Check the oil level	x			
7	Check the acid content of the oil (acid test)			x	
8	Oil change			x	
9	Check that the crankcase heater is working	x			
10	Check that the output control is working	x			
11	Check the refrigerant side for leaks	x			
12	Check high/low pressure switching equipment	x			
	Air-cooled Condenser				
20	Optical check for dirt, damage and corrosion	x		x	
21	Measure the condensing temperature	x			
22	Measure the refrigerant side subcooling temperature at the condenser outlet	x			
23	Measure the medium temperature at condenser inlet and outlet	x			
24	Check that the condensation pressure control is functioning properly	x			
25	Check the refrigerant side for leaks	x			
	Evaporator				
30	Optical check for dirt, damage and corrosion	x			
31	Measure refrigerant overheating temperature	x			
32	Measure the medium temperature at the evaporator inlet and outlet	x			
33	Measure the anti-freeze temperature (freezing point) of the heat transfer media	x			
34	Check the water and refrigerant side for leaks	x			

Items	Explanation	Annual	semi anual	as required	Remark
	Parts in the refrigeration circuit/water circuit				
40	Optical check for dirt, damage and corrosion	x	x		
41	Check insulation for damage	x			
42	Check filter dryer for blockage	x			
43	Replace filter dryer			X	If components are replaced
45	Check all pipes carrying refrigerant for corrosion and damage	x			
	Fans				
50	Optical check for dirt, damage and corrosion	x		x	
51	Check fixings and bearings	x			
52	Check flexible connection for tightness (electrical connection)	x			
	Pump and Piping				
60	Optical check for dirt, damage and corrosion	x			
61	Check fixing parts and bearings	x			
62	Check the safety function of the safety switching devices	x			
63	Check pump/mechanical seal for leaks	x		x	
	Water Filters				
70	Optical check for dirt, damage and corrosion	x		x	
71	Clean filters	x		x	
72	Check filters for damage	x			

Items	Explanation	Annual	semi anual	as required	Remark
	Expansion Tank				
80	Optical check for dirt, damage and corrosion	x			
81	Check fixing	x			
	Control cabinet				
90	Optical check for dirt, damage and corrosion	x		x	
91	Check fixing	x			
92	Check all threaded connections	x			
93	Check all indicator lights and error messages	x			
94	Check the temperature and pressure sensors are functioning properly	x			
95	Check the function of the motor protection switches	x			
96	Check 24 VDC and supply voltage	x		x	
97	Check control cabinet heater	x			
99	Check control cabinet filter and if necessary replace/clean	x			
	Documents and labelling				
110	All documents such as operating instructions, diagrams, circuit plans, system log are present	x		x	
111	Rating plate and labels are clearly legible	x		x	
	Refrigeration circuit leak check	x			

III. Product Registration

PDF download: <http://www.kkt-chillers.com/en/downloads/product-registration/>

Product Registration



ait-deutschland GmbH
Industriestraße 3 · 95359 Kasendorf · Germany
www.kkt-chillers.com

Chiller details*1

Type	
SAP-No.	
Construction year	
Serial-No.	
Date of first start-up [DD MM YYYY]	

Responsible service company*2

- Local Company
 Service contract should be offered by KKT chillers

End-User details

Customer device	
Company name	
Street	
Zipcode / City	
State	
Place of installation	

Responsible contact person

Name	
Phone number (mobile)	
e-mail	

Technical feedback

- The refrigerating system is installed horizontally, if necessary with vibration damping.
 The dirt traps in the system have been cleaned after flushing.
 The circuit water corresponds to the requirements in the instruction manual. Any necessary water additives (antifreeze; biocide;...) have been added.
 Unit works without faults.

24/7

Customer Support

Servicehotline
+49 9228 9977 7190

Please complete this data sheet and fax or email it to:
+49 9228 9977 7474 or service@kkt-chillers.com

KKT chillers will use this information to process your product registration.
Write legible, please! Thanks for your cooperation! Your KKT chillers team.

*1 = The chiller details are located on the name plate at the equipment.

*2 = responsible for chiller maintenance and service.

Product registration - 2015/07/21

IV. Information Ecodesign

Information Ecodesign (EU) 2016/2281
high temperature process chillers



manufacturer: ait-deutschland GmbH			
Model	OCLC25		
Option high-temperature	No		
Voltage ¹	400/3/50		
Type of condensing	air-cooled		
Refrigerant fluid	R410A		
Item	Symbol	Value	Unit
Operating temperature	t	7	°C
Seasonal energy performance ratio	SEPR	4,66	
Annual electricity consumption	Q	42.259	kWh/a
Parameters at full load and reference ambient temperature at rating point A			
Rated refrigeration capacity	P _A	26,55	kW
Rated power input	D _A	2,73	kW
Rated energy efficiency ratio	EER _{OCA}	9,73	
Parameters at rating point B			
Declared refrigeration capacity	P _B	29,80	kW
Declared power input	D _B	3,61	kW
Declared energy efficiency ratio	EER _{OC,B}	8,26	
Parameters at rating point C			
Declared refrigeration capacity	P _C	30,63	kW
Declared power input	D _C	4,01	kW
Declared energy efficiency ratio	EER _{OC,C}	7,64	
Parameters at rating point D			
Declared refrigeration capacity	P _D	32,87	kW
Declared power input	D _D	4,98	kW
Declared energy efficiency ratio	EER _{OC,D}	6,60	
Other Items			
Capacity control	staged		
Degradation co-efficient chillers (rating point B)	C _{dc}	0,99	
Degradation co-efficient chillers (rating point C)	C _{dc}	0,99	
Degradation co-efficient chillers (rating point D)	C _{dc}	0,99	
GWP of the refrigerant		2088	kg CO ₂ eq (100 years)

¹ The voltage refers to the operating voltage of the main components and can deviate from the supply voltage by using a transformer.

Revision: 0 /